

SEÇÕES TRANSVERSAIS
ESC.: H=1/200
V=1/200

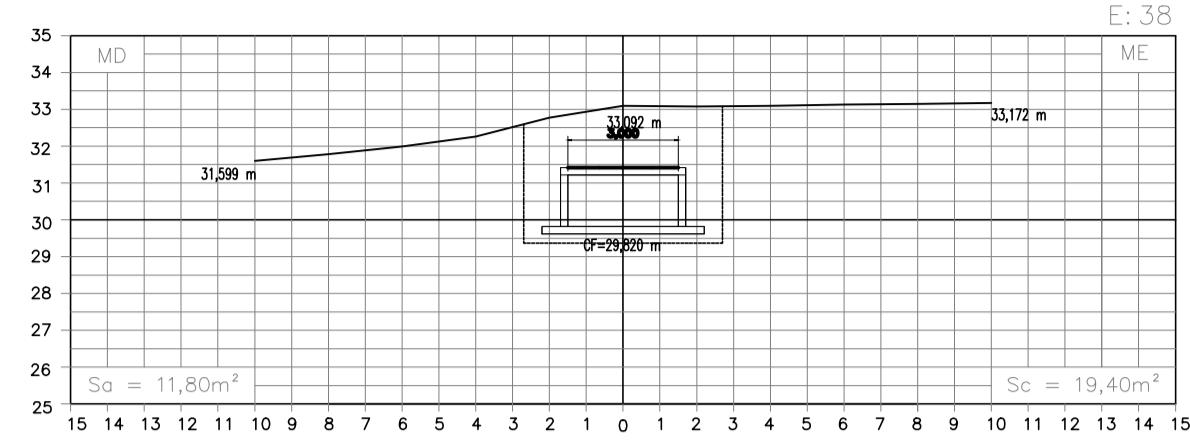

SEÇÕES TRANSVERSAIS
ESC.: H=1/200
V=1/200

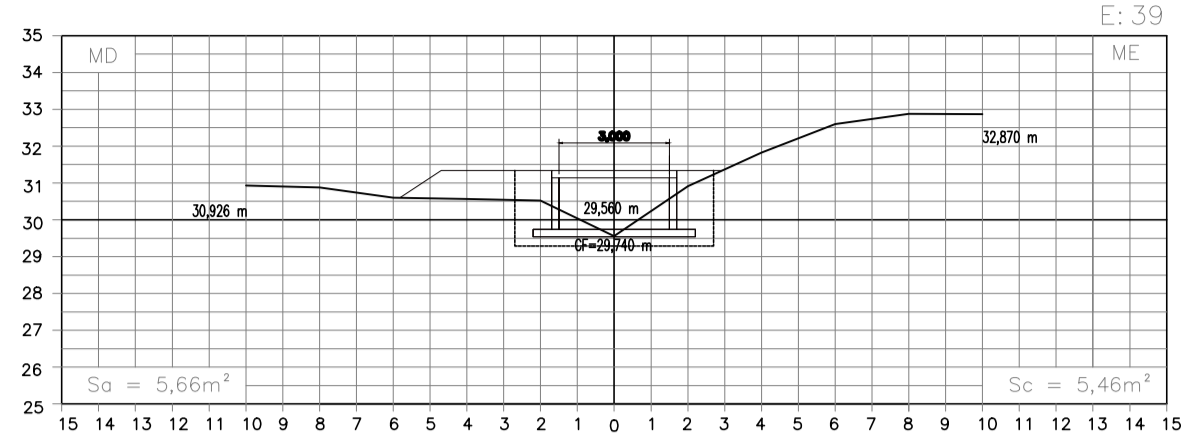

SEÇÕES TRANSVERSAIS
ESC.: H=1/200
V=1/200

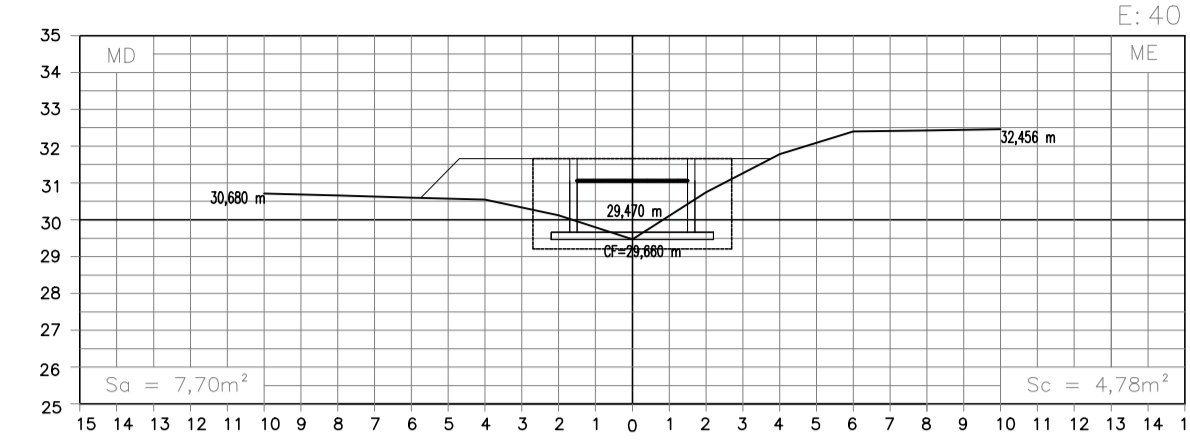

SEÇÕES TRANSVERSAIS
ESC.: H=1/200
V=1/200

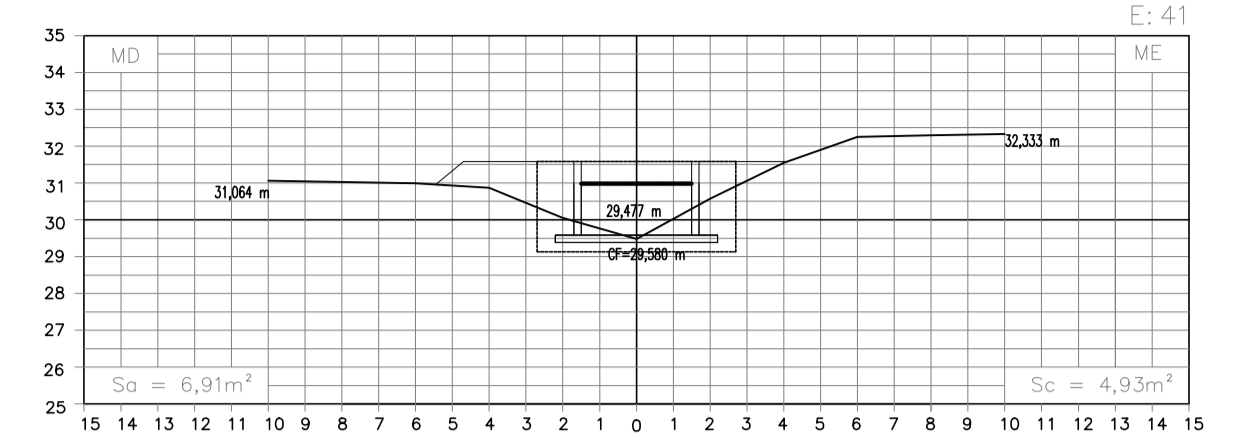

SEÇÕES TRANSVERSAIS
ESC.: H=1/200
V=1/200

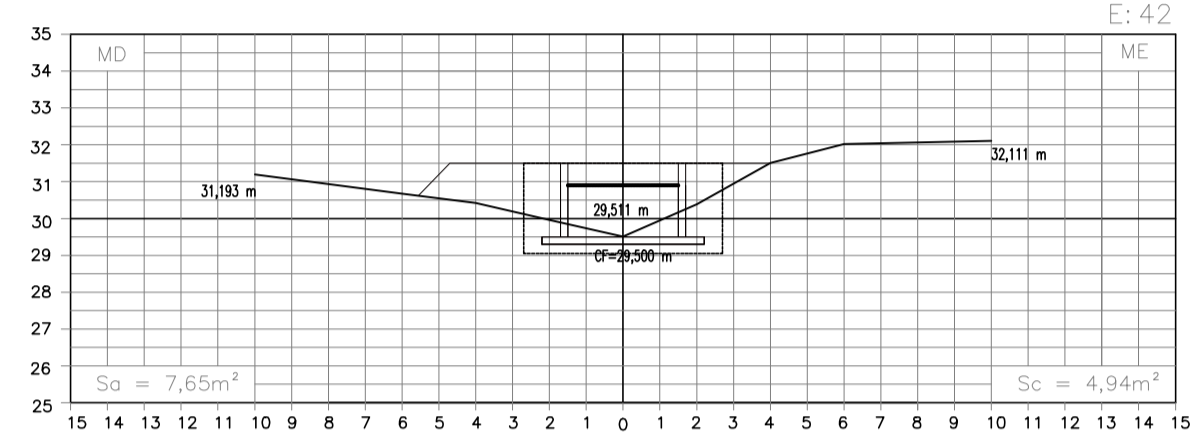

SEÇÕES TRANSVERSAIS
ESC.: H=1/200
V=1/200

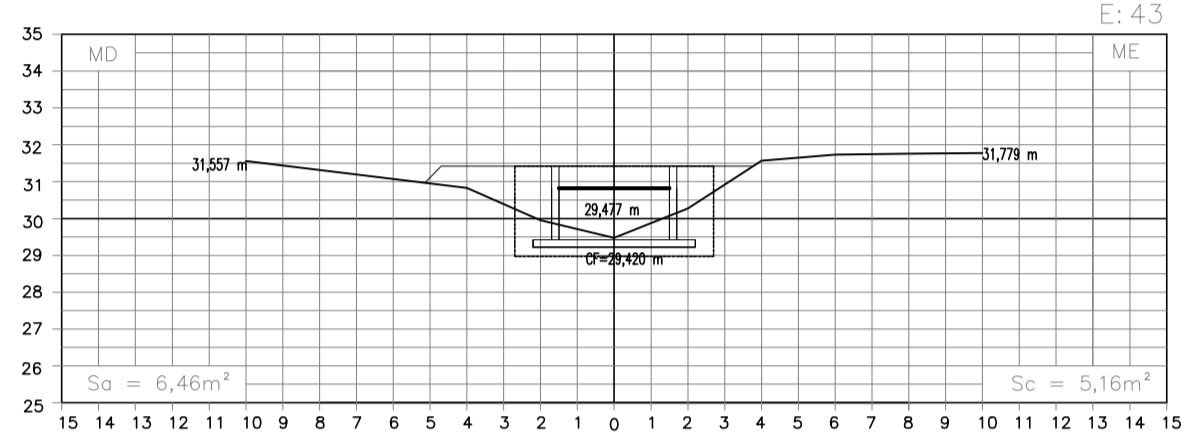

SEÇÕES TRANSVERSAIS
ESC.: H=1/200
V=1/200

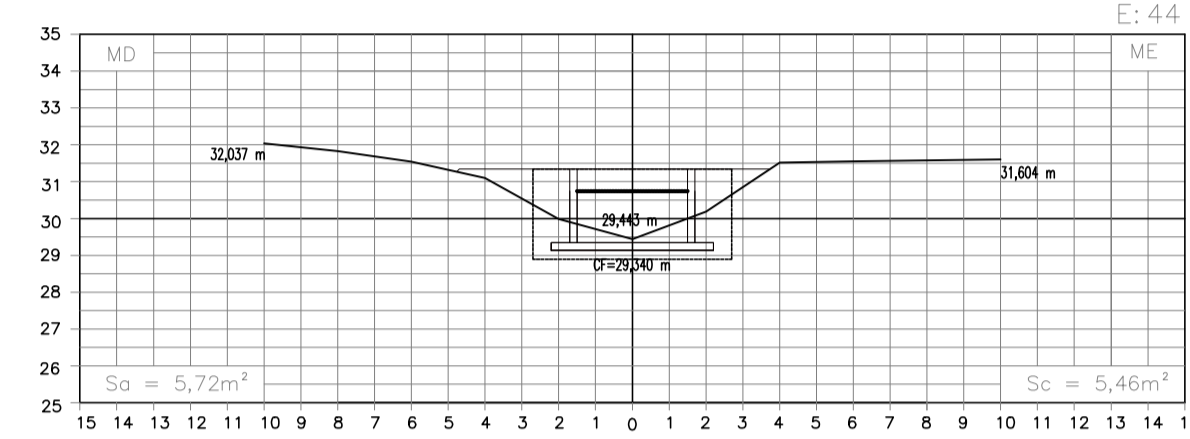

SEÇÕES TRANSVERSAIS
ESC.: H=1/200
V=1/200

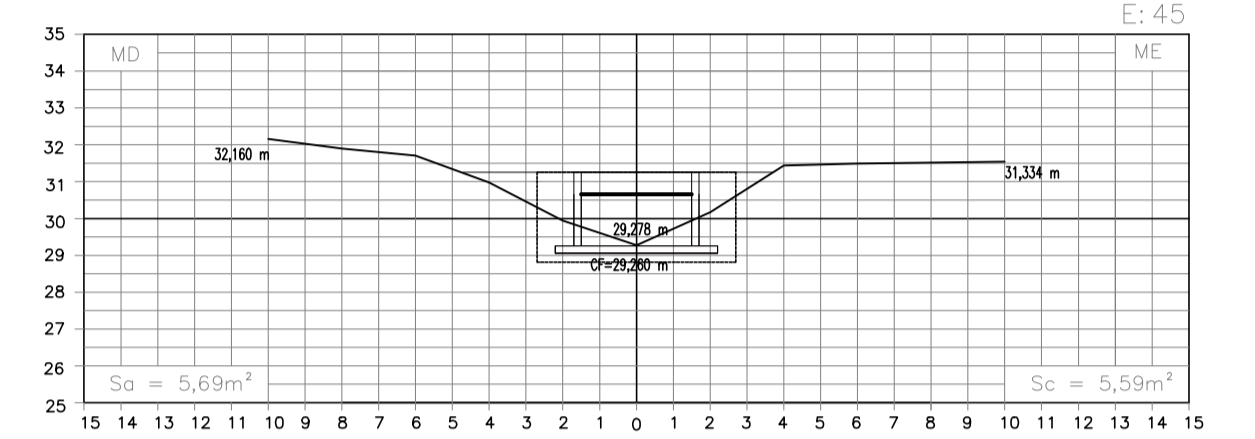

SEÇÕES TRANSVERSAIS
ESC.: H=1/200
V=1/200

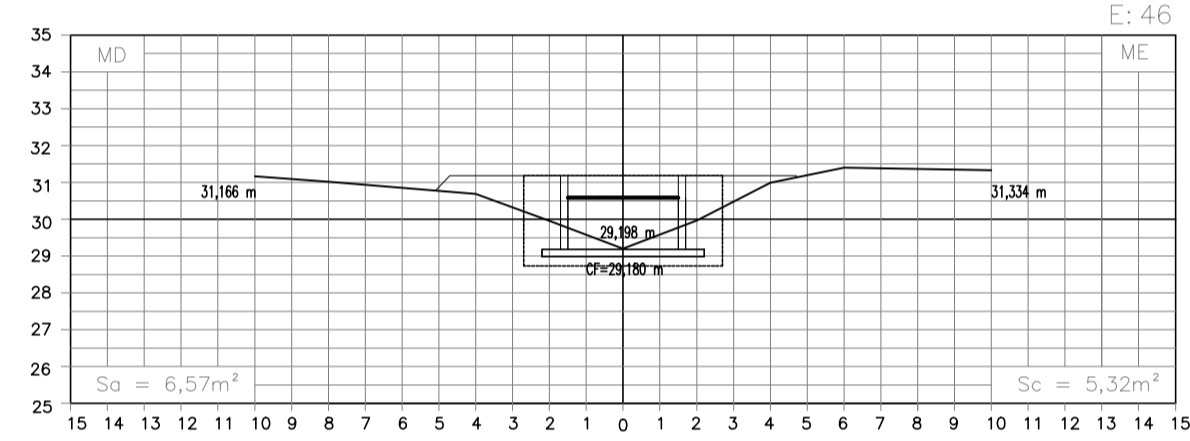

SEÇÕES TRANSVERSAIS
ESC.: H=1/200
V=1/200

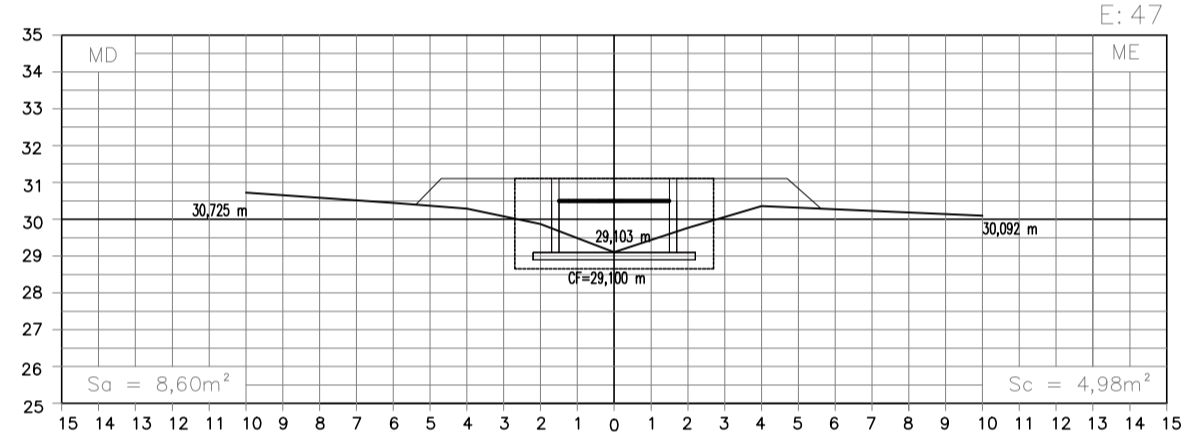

SEÇÕES TRANSVERSAIS
ESC.: H=1/200
V=1/200

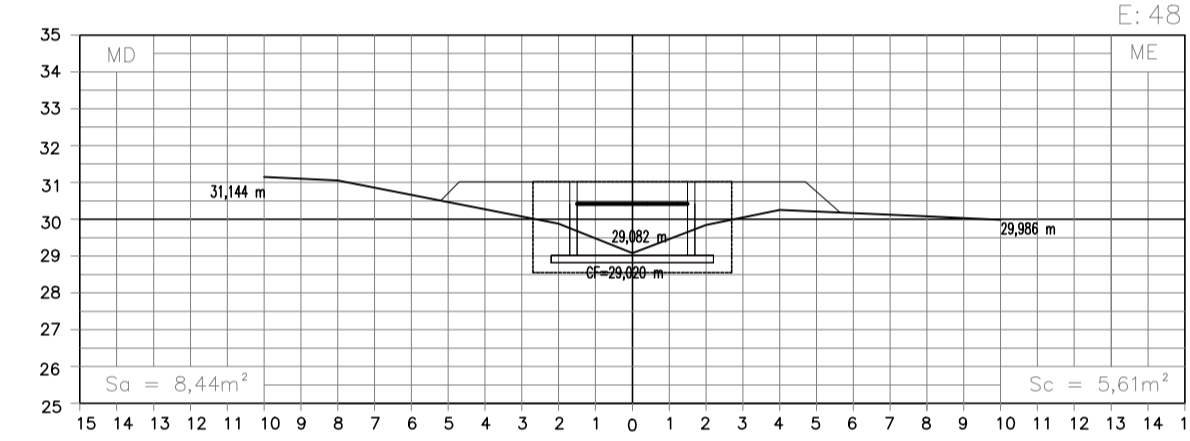

SEÇÕES TRANSVERSAIS
ESC.: H=1/200
V=1/200

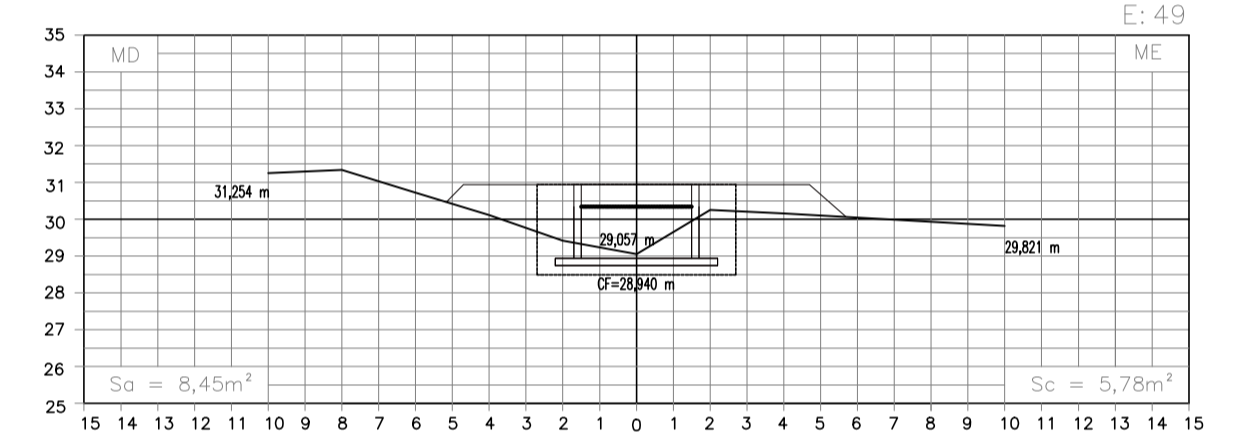

SEÇÕES TRANSVERSAIS
ESC.: H=1/200
V=1/200

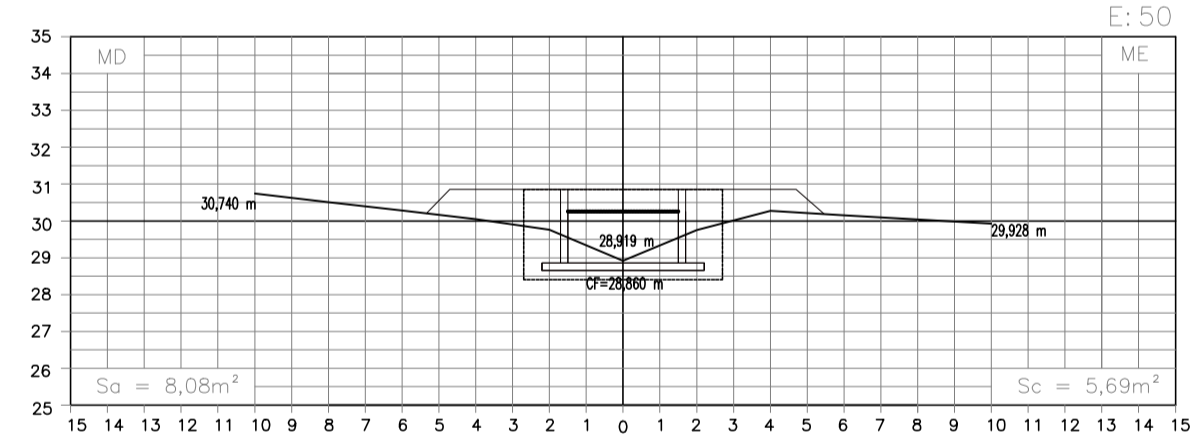

SEÇÕES TRANSVERSAIS
ESC.: H=1/200
V=1/200

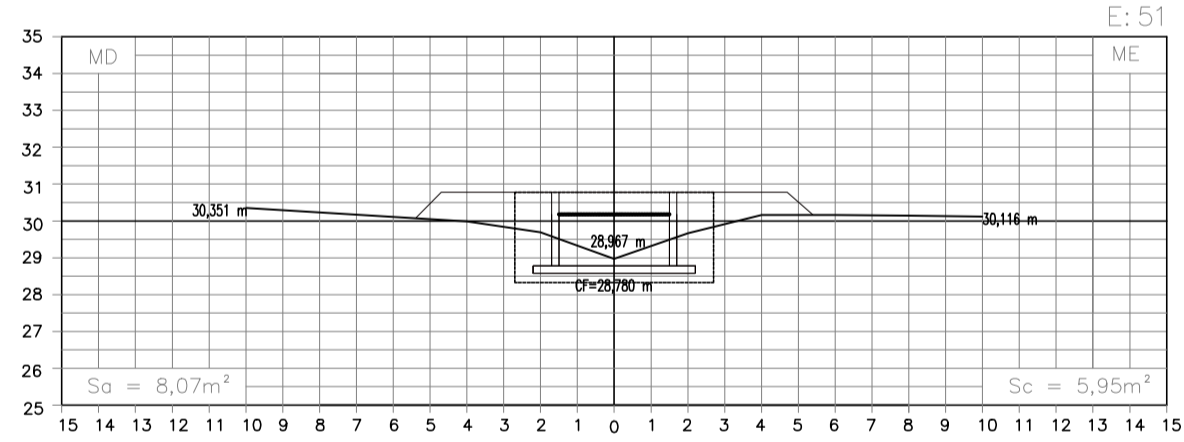

SEÇÕES TRANSVERSAIS
ESC.: H=1/200
V=1/200

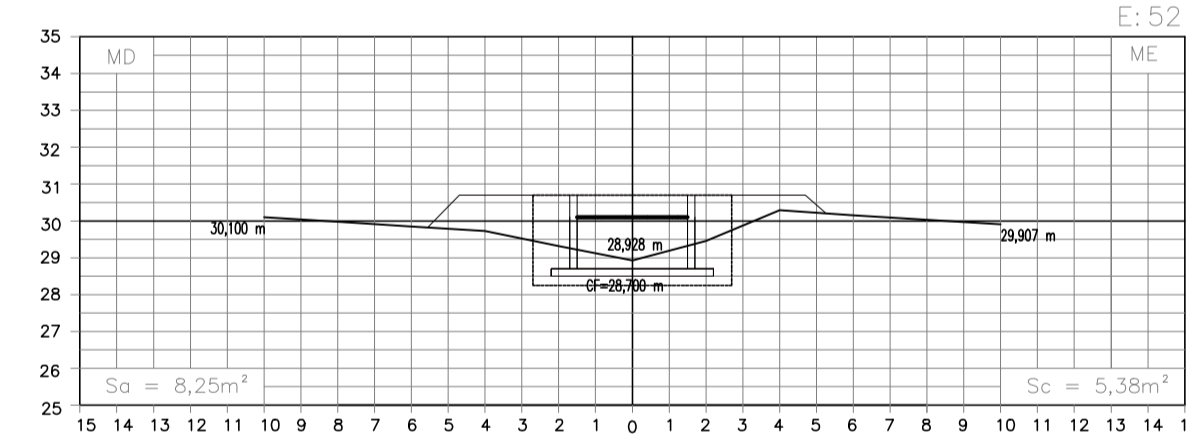

SEÇÕES TRANSVERSAIS
ESC.: H=1/200
V=1/200

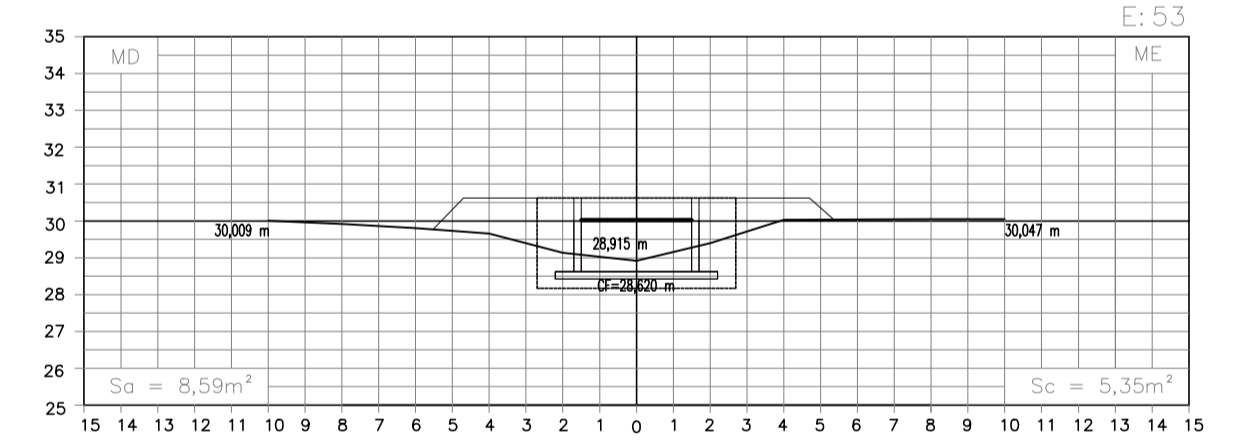

SEÇÕES TRANSVERSAIS
ESC.: H=1/200
V=1/200

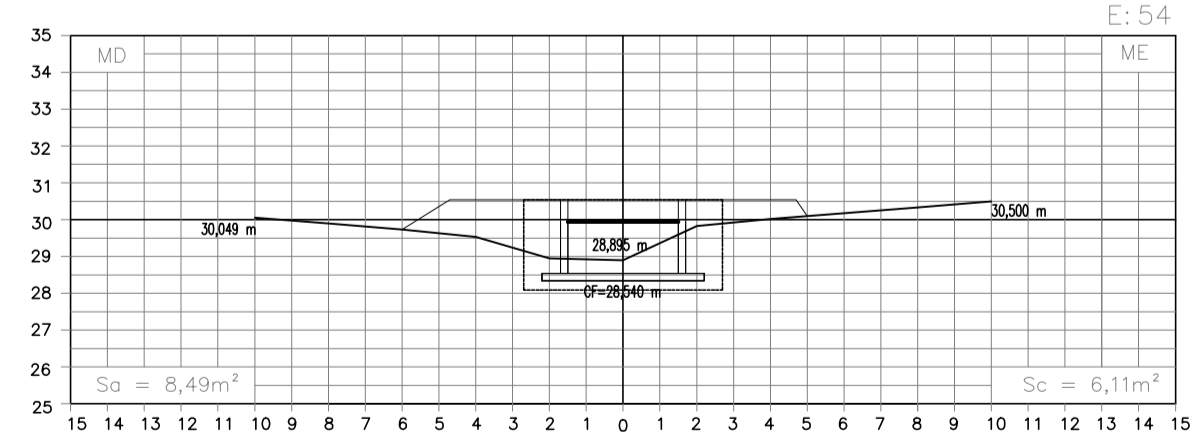

SEÇÕES TRANSVERSAIS
ESC.: H=1/200
V=1/200

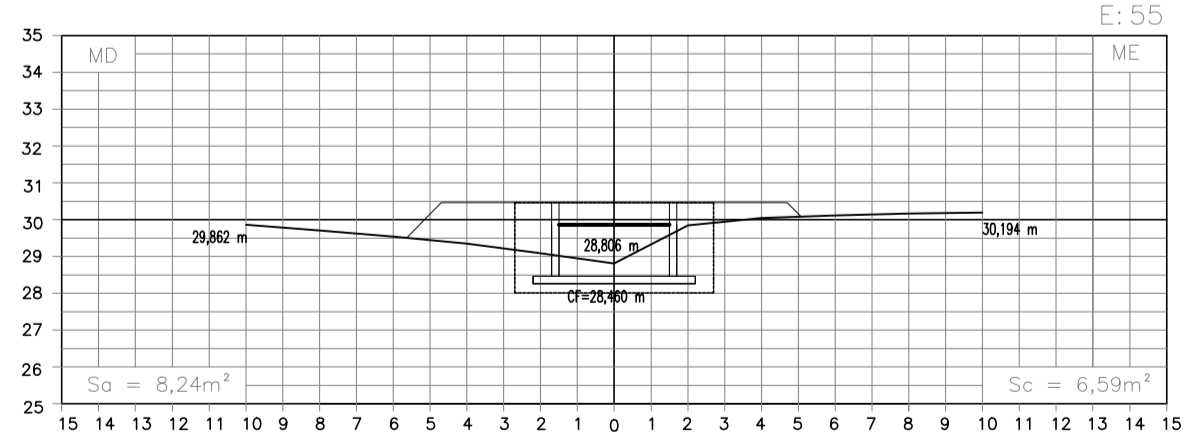

SEÇÕES TRANSVERSAIS
ESC.: H=1/200
V=1/200

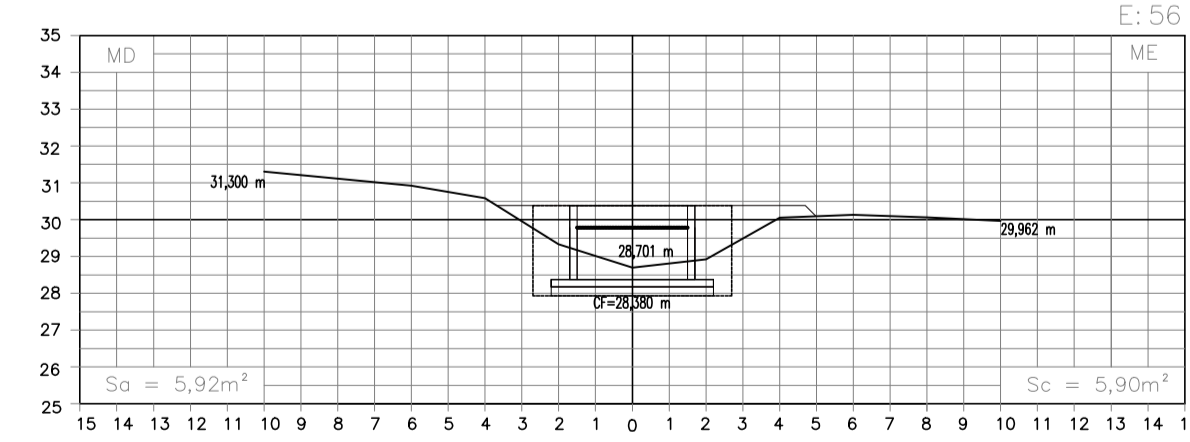

Escala: 1:1000

 PREFEITURA MUNICIPAL DE PRESIDENTE KENNEDY – ES			
SECRETARIA MUNICIPAL DE OBRAS			
PROJETO DE DRENAGEM DA GALERIA DO CÓRREGO BATALHA – 2ª ETAPA			
LOCAL: SEDE – PRESIDENTE KENNEDY – ES			
CONTEUDO:		DESENHO:	
REVESTIMENTO DO CORREGO BATALHA SEÇÕES TRANSVERSAIS			
FOLHA:	ADMINISTRAÇÃO:	ADMINISTRAÇÃO:	RESPONSÁVEL TÉCNICO:
3/6	MIGUEL ANGELO LIMA QUALHANO SECRETÁRIO DE OBRAS	AMANDA QUINTA RANGEL PREFEITA MUNICIPAL	DIOGO WAGNER ENGENHEIRO CIVIL CREA MG-15960/D